

Results from Recent Shattered Pellet Injection Research on DIII-D

by

D. Shiraki¹, J.L. Herfindal¹, L.R. Baylor¹,
N.W. Eidietis², E.M. Hollmann³, R.A. Moyer³,
C.J. Lasnier⁴

¹ Oak Ridge National Laboratory

² General Atomics

³ University of California, San Diego

⁴ Lawrence Livermore National Laboratory

Presented at the
Theory and Simulation of Disruptions Workshop
Princeton Plasma Physics Laboratory
Princeton, NJ

July 18, 2017



Summary: Addition of 2nd SPI system beginning to generate first results

- Slight difference in mitigation between the two injectors observed, but still good mitigation overall
- No obvious evidence of localized heat loads caused by radiation asymmetry (so far)
- Multiple pellets may actually reduce mitigation, compared with a single pellet
- Possible mechanism: multiple pellets causes disruption sooner, which may reduce amount of neon entering pre-TQ plasma

2nd SPI system has been installed on DIII-D

- Installed in 2016
- Experiments began in 2017
- ITER prototype design injects up to three pellets
 - Pellets formed from arbitrary mixtures of Ne, D₂
- Mechanical punch planned, will allow Ar pellets

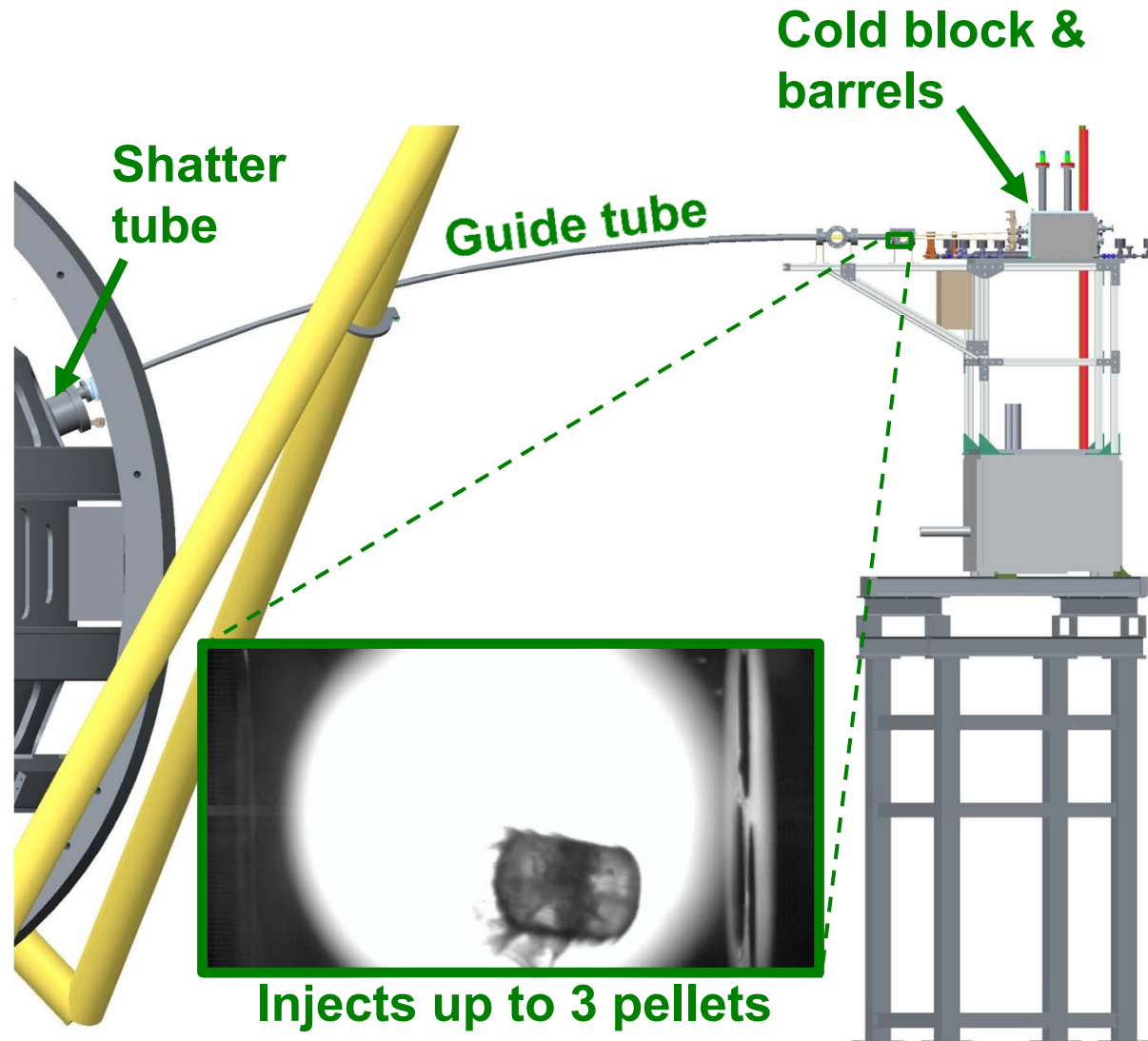

2nd SPI system has been installed on DIII-D

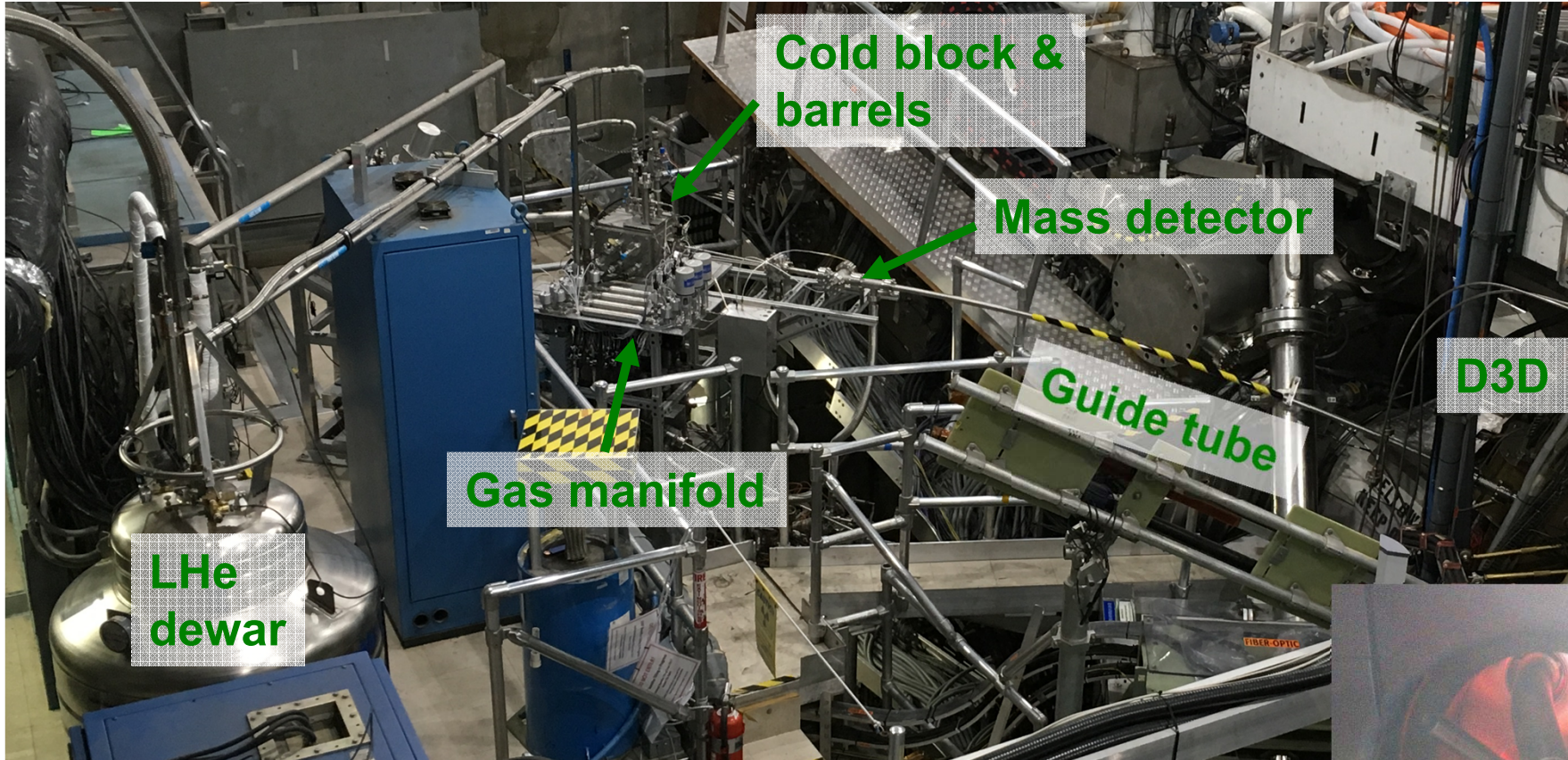

Addition of 2nd SPI significantly extends experimental capabilities

- DIII-D may be only machine besides ITER to have multiple SPIs
- Effectively doubles coverage of disruption diagnostics
 - Both injectors located at same poloidal position
 - Toroidally separated by 120°
- Having two injectors allows significant modification to one while preserving the other
 - i.e. Changing pellet trajectory

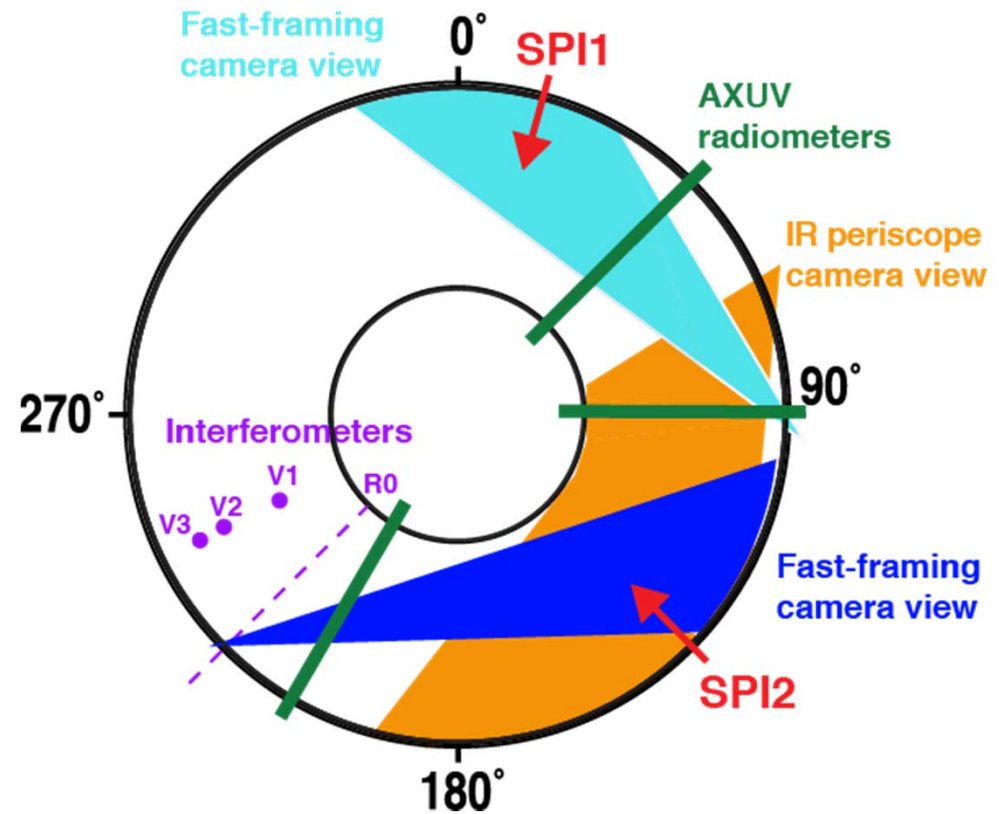

- **Characterizing asymmetric effects**
 - One pellet at a time, from different ports
- **Mitigating thermal and EM loads with multiple pellets**
 - Two pellets together, one from each port
- **Additional capabilities, and future work**

- **Characterizing asymmetric effects**
 - One pellet at a time, from different ports
- Mitigating thermal and EM loads with multiple pellets
 - Two pellets together, one from each port
- Additional capabilities, and future work

2nd SPI allows better detection of potential localized heat loads

- Will the faster delivery by SPI lead to TQ with more asymmetric impurity distribution, and thus localized heat loads?

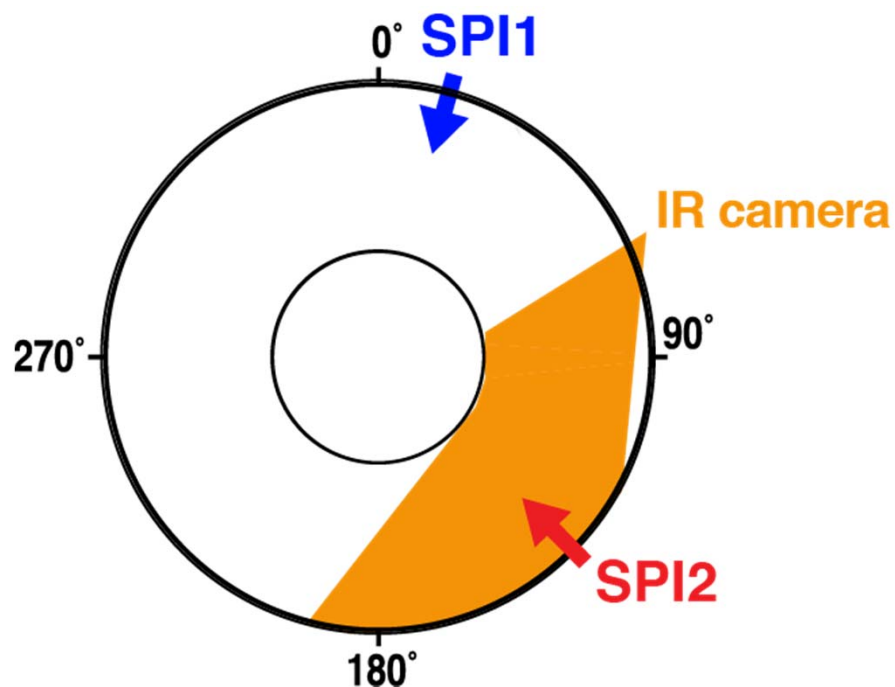

Effect of MGI vs SPI

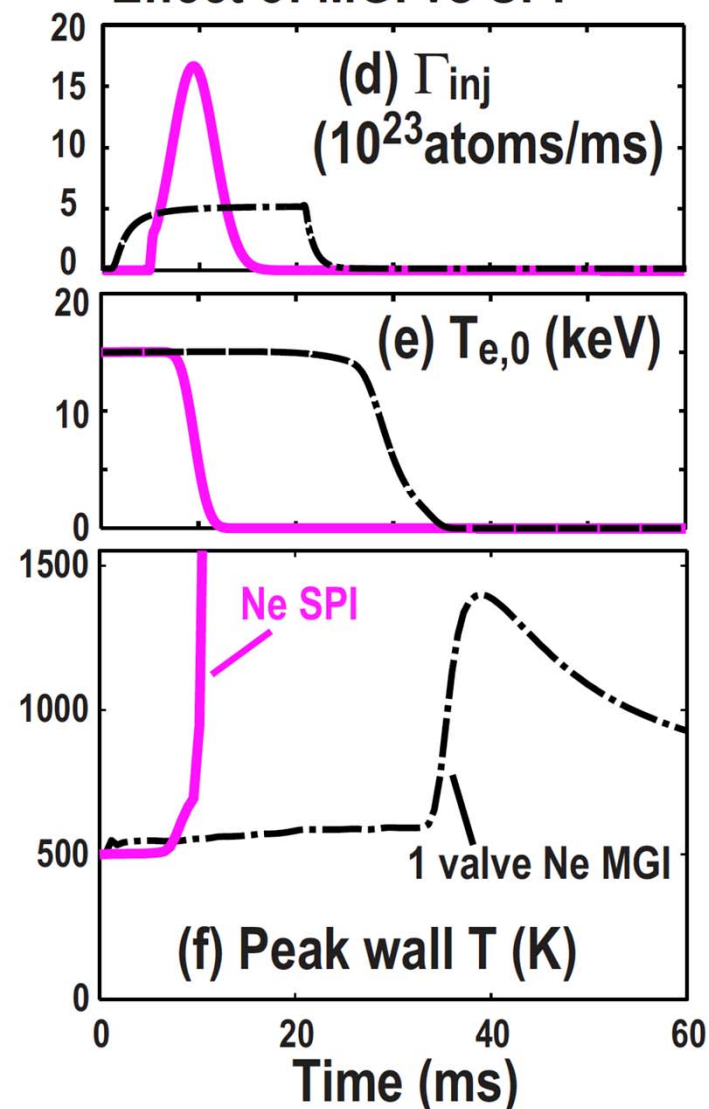

Hollmann et al., Phys. Plasmas 22, 021802 (2015)

Slight difference observed between performance of two injectors, but still good overall mitigation

- **SPI1** appears to mitigate slightly better than **SPI2**
 - Good radiation data are are unavailable
- Possible difference is amount of helium propellant entering plasma

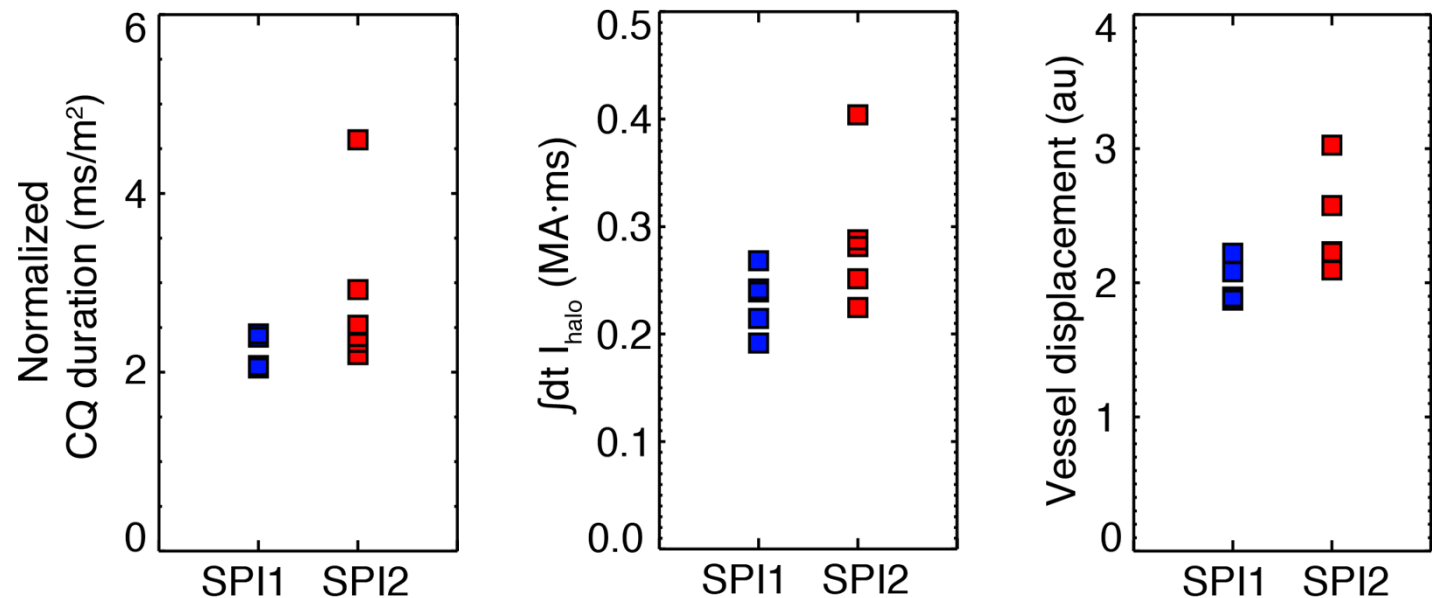

Slight difference observed between performance of two injectors, but still good overall mitigation

- **SPI1** appears to mitigate slightly better than **SPI2**
 - Good radiation data are are unavailable
- Possible difference is amount of helium propellant entering plasma

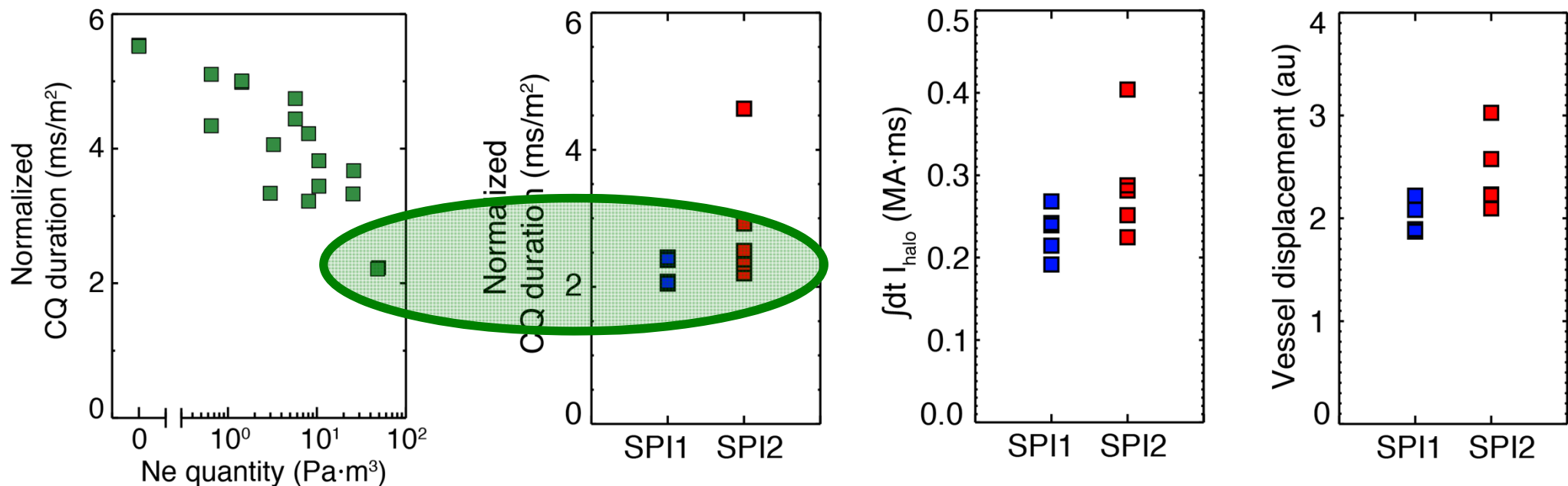

- Compared to previous parameter scans, both injectors still show good performance

Fast cameras show solid fragments entering plasma, but detailed analysis still ongoing

SPI1: Toroidal angle = 15°

SPI2: Toroidal angle = 135°

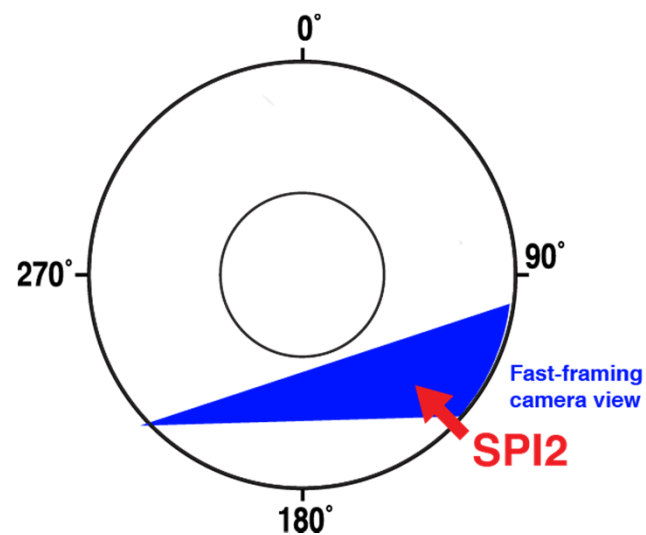
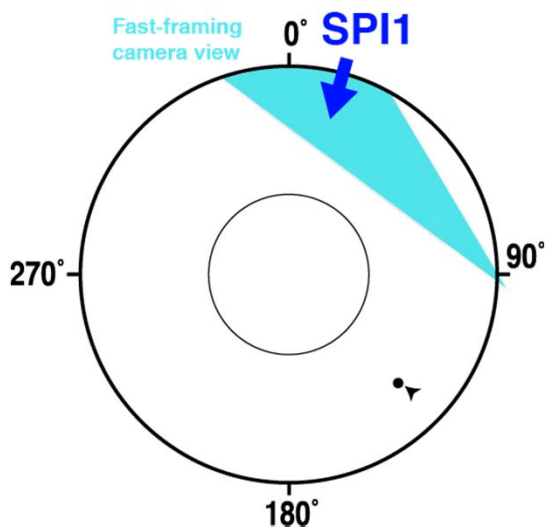
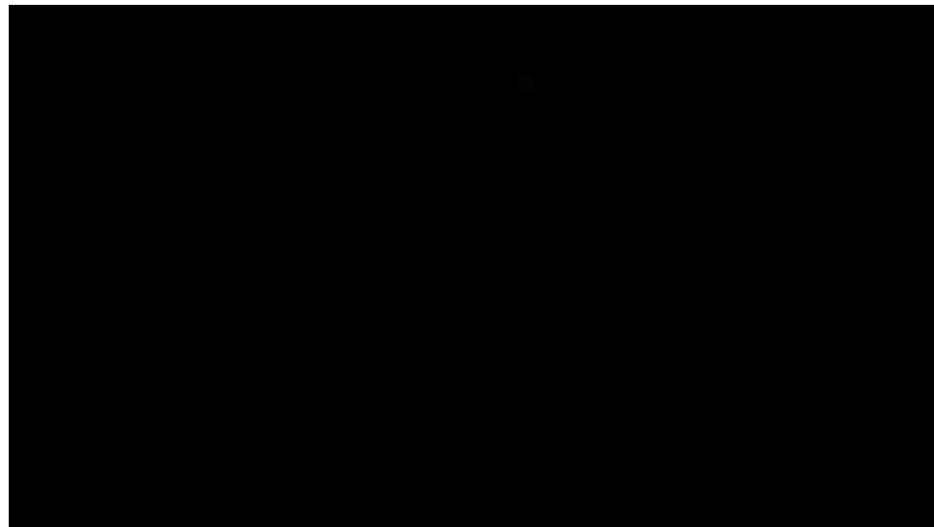
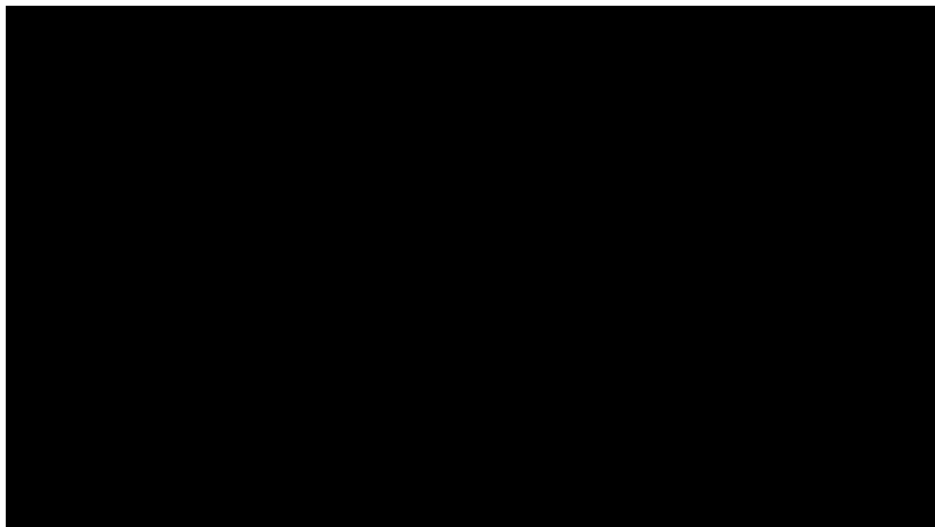

Density perturbations consistent with higher overall performance of SPI1, inconclusive on asymmetric spreading

- Slightly higher assimilation observed for SPI1, which could explain improved mitigation
- NIMROD simulations of MGI have predicted asymmetric toroidal spreading of impurities
 - Izzo et al., Nucl. Fusion 55 (2015) 073032

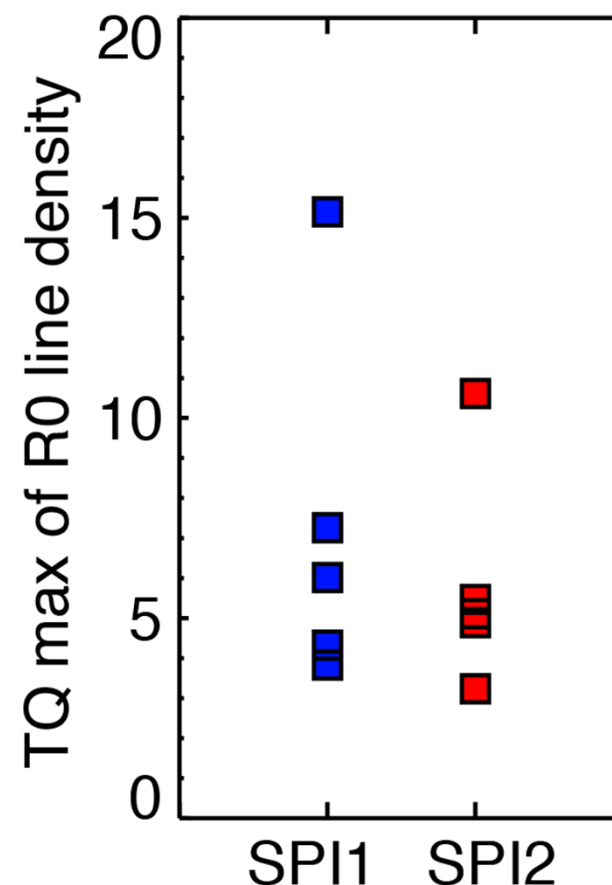
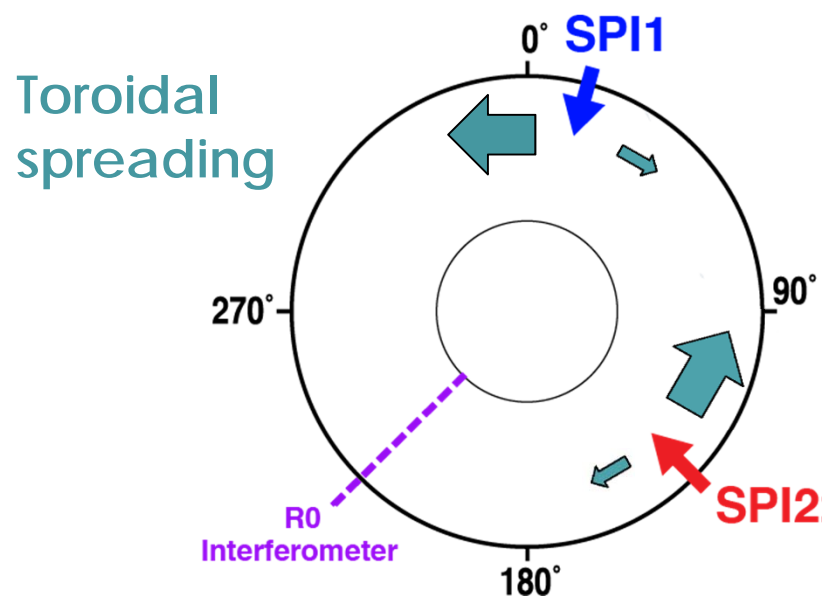

No obvious evidence of large heat loads near injection port

- IR camera previously used to detect radiative heat loads

- Comparing the two SPIs, significant scatter in data
 - Further analysis ongoing!

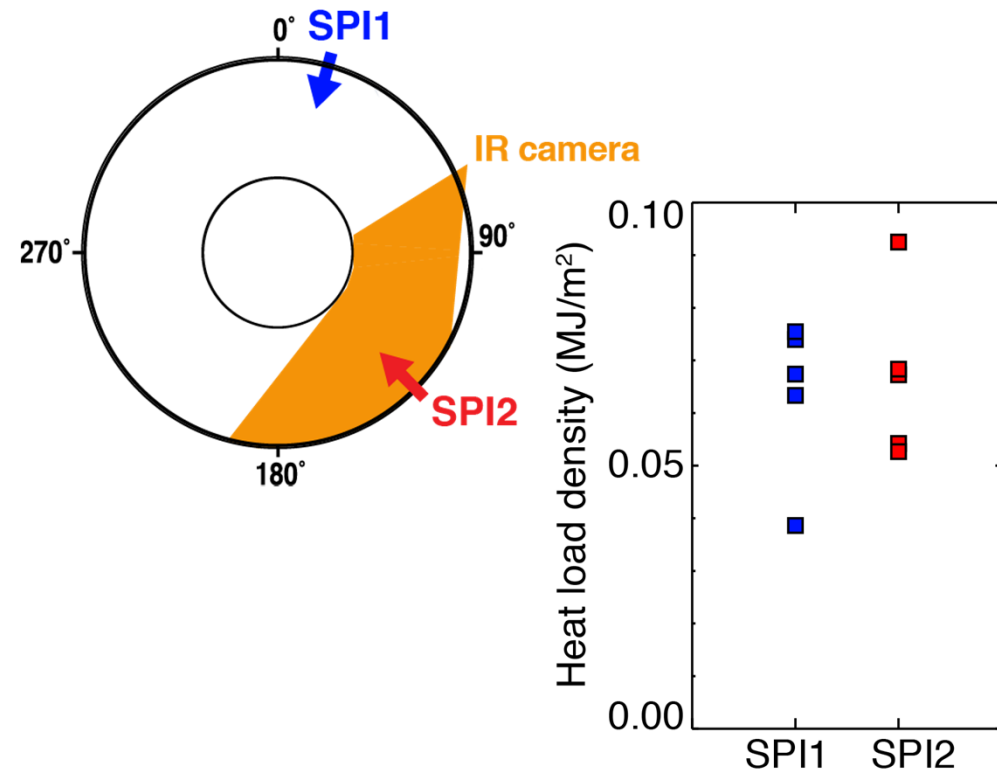
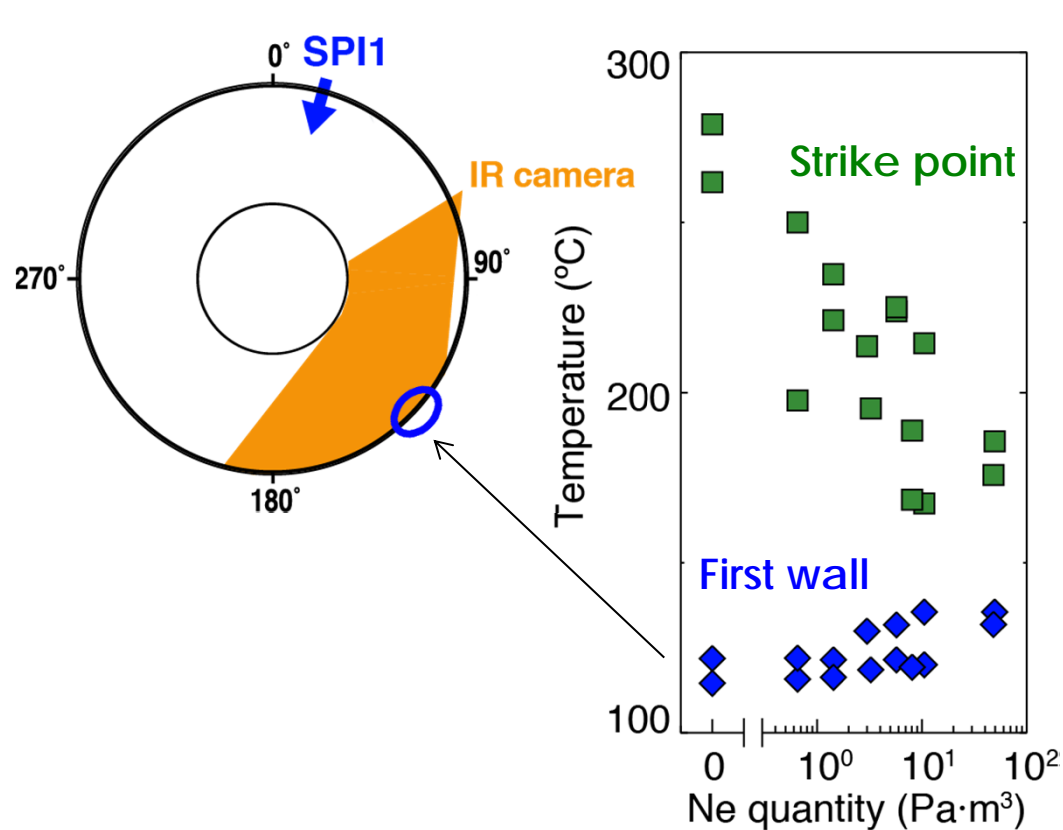

Outline

- Characterizing asymmetric effects
 - One pellet at a time, from different ports
- **Mitigating thermal and EM loads with multiple pellets**
 - Two pellets together, one from each port
- Additional capabilities, and future work

Injecting multiple pellets is a key part of the ITER DMS strategy

- ITER will inject multiple pellets “simultaneously” in order to deliver large quantities
- How simultaneous must they be?
- Are multiple small pellets the same as one large pellets?

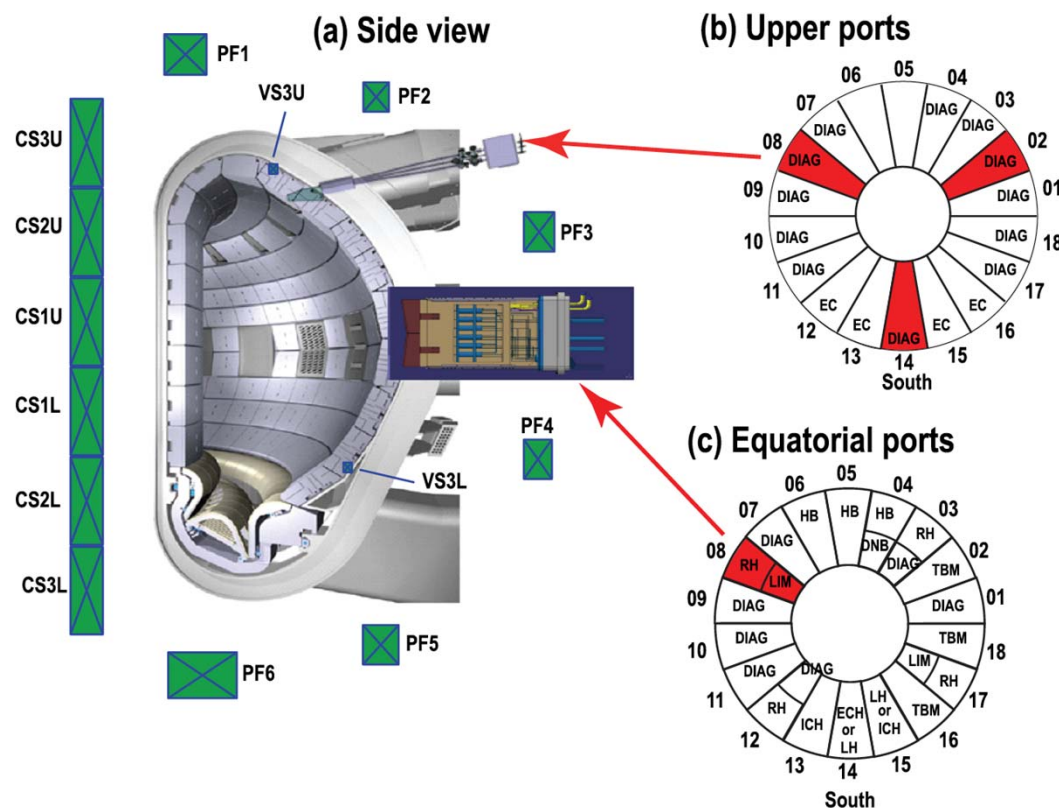

- DIII-D may be only machine besides ITER with multiple SPIs!

Experiment was designed to measure required timing for multiple pellets to work together

- Vary the relative timing of two dissimilar pellets

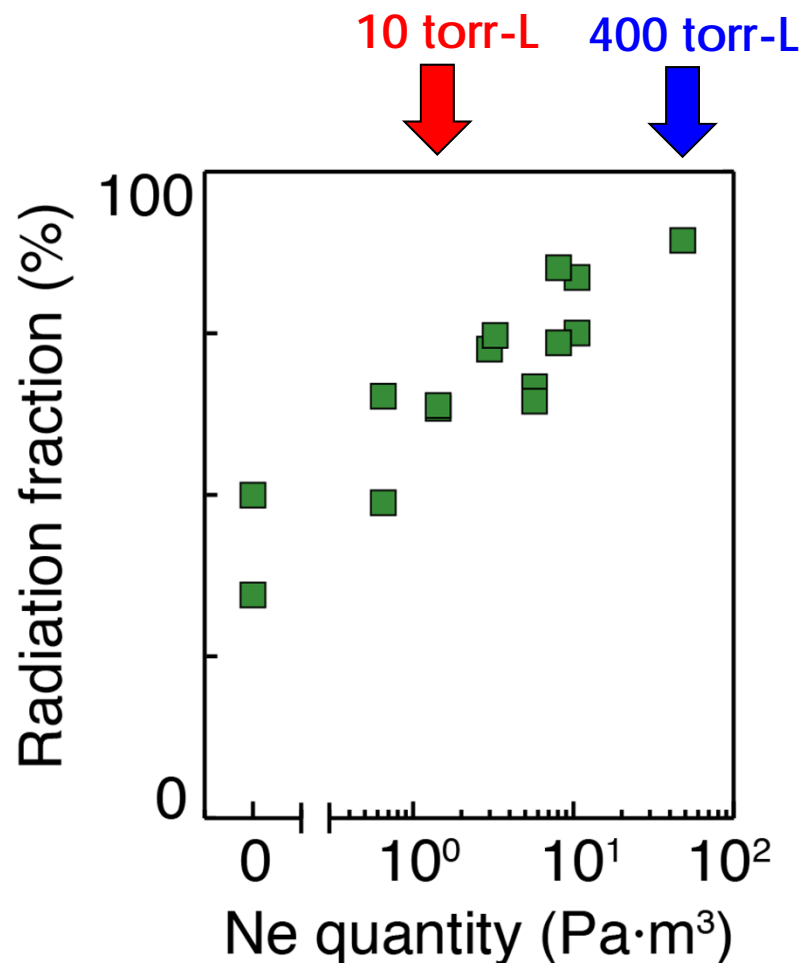

Expected result: Radiation fraction

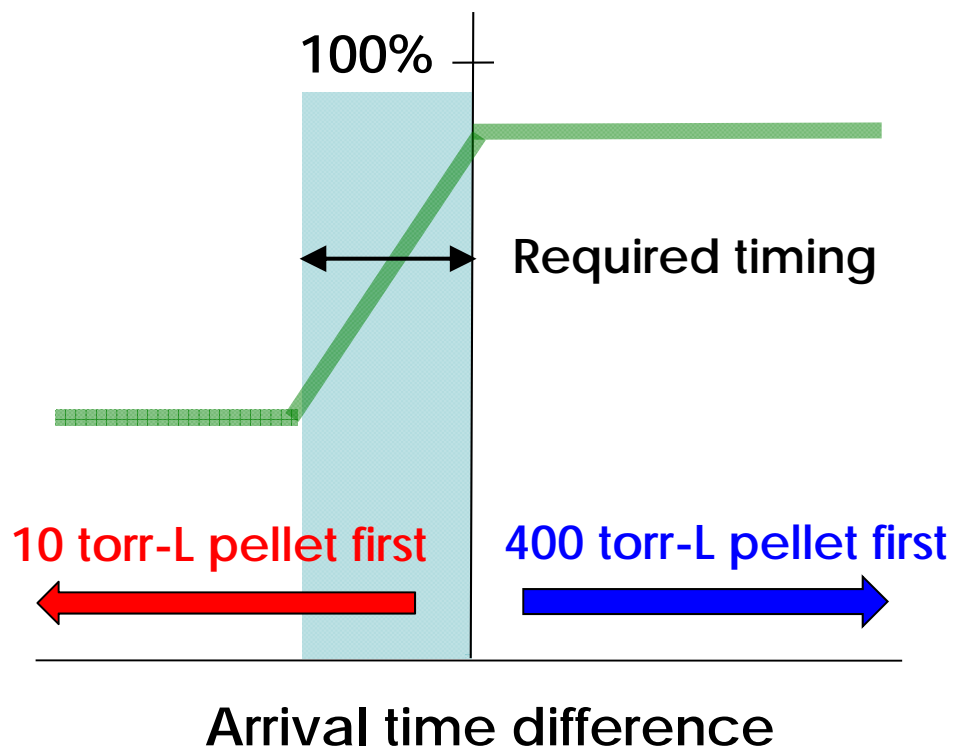

Radiation fraction suggests two pellets may do worse than one pellet alone

- Expected behavior seen at both extremes (high/low limits)
- Two simultaneous pellets ($\Delta t = 0$) appears to have lower radiation than upper limit

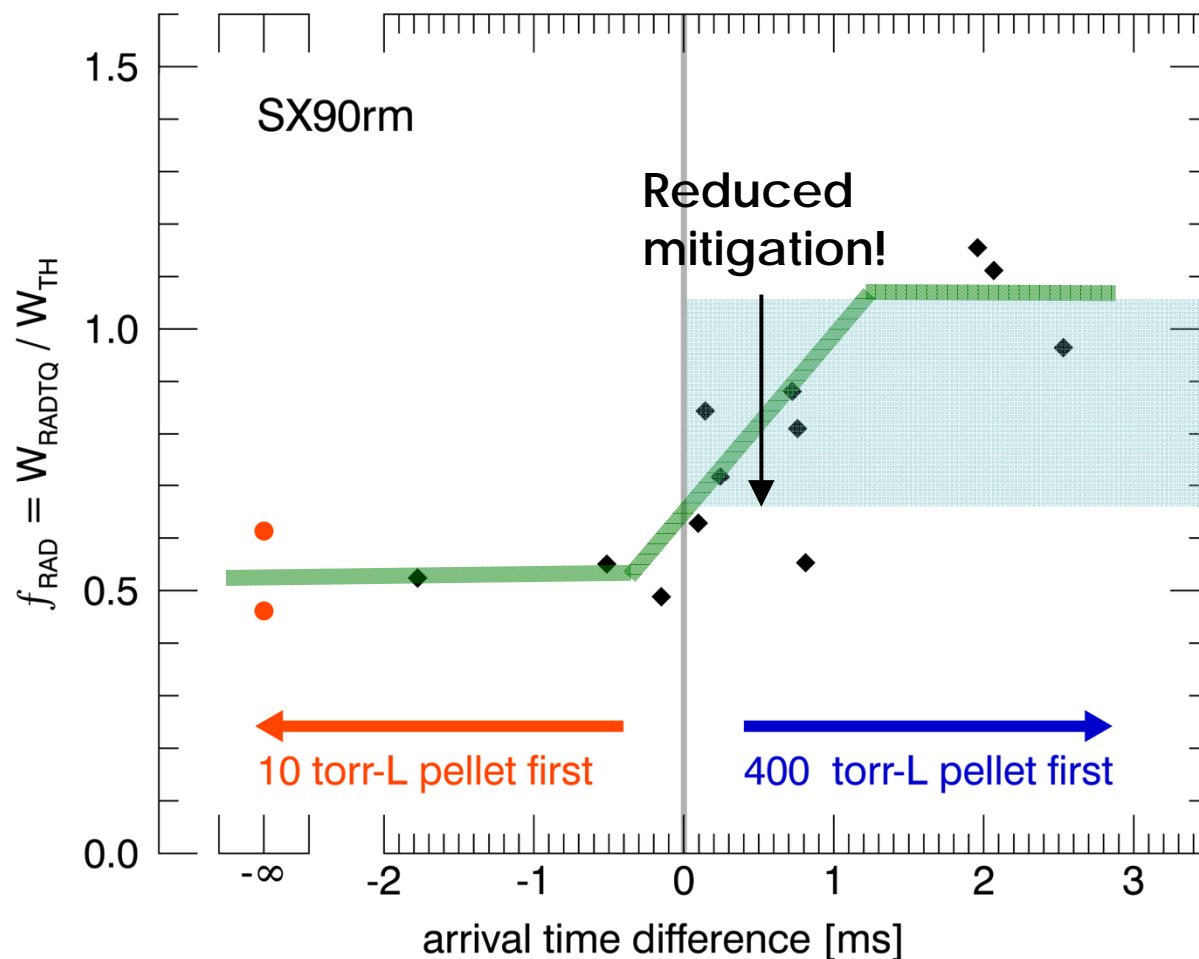

CQ characteristics show same reduction, with two pellets

- Consistent with reduction in TQ radiation fraction
- Reduced mitigation observed for other CQ metrics
 - Vessel displacement
- CQ timescale is a 'global' quantity

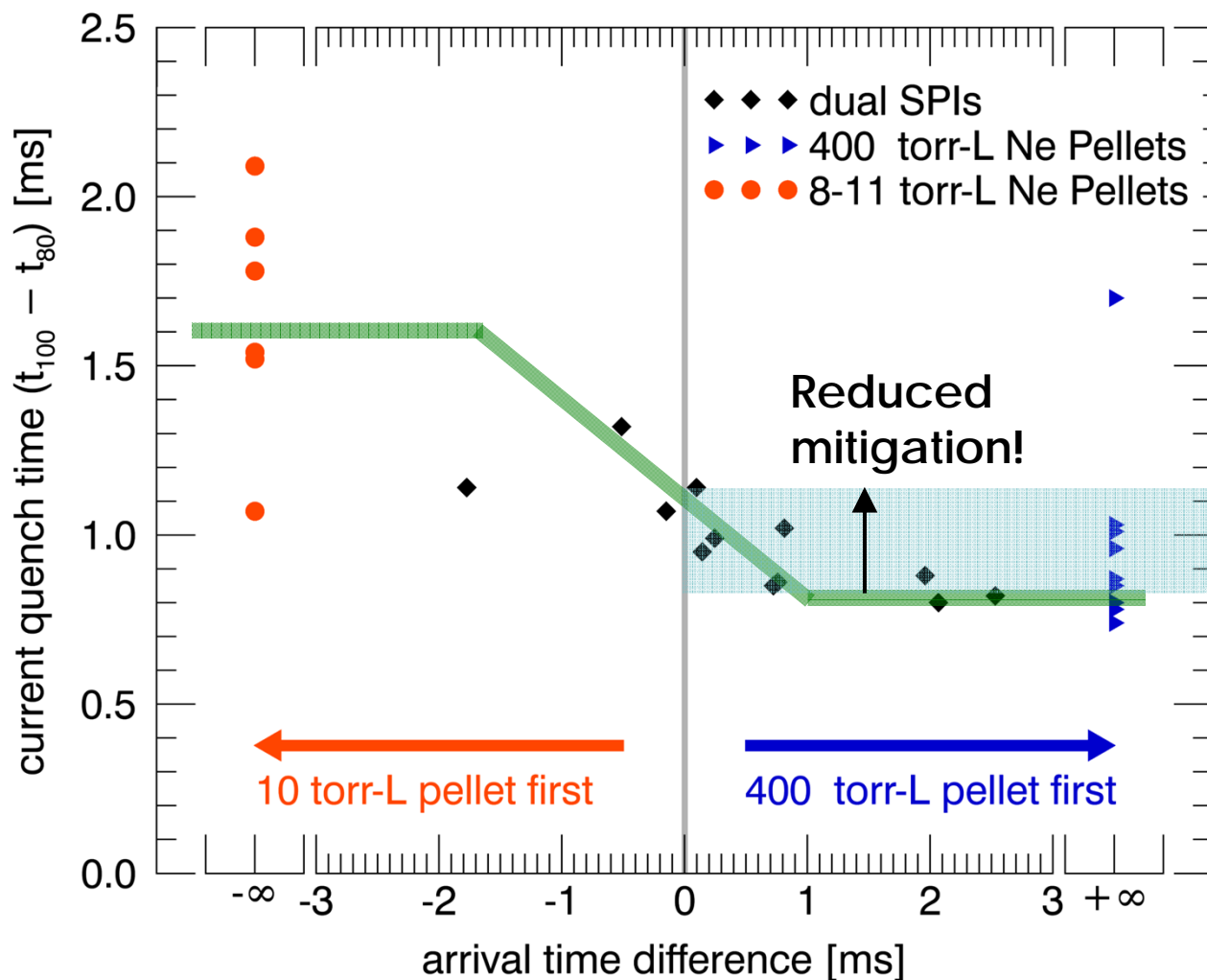

IR imaging is currently inconclusive

- Clear difference observed between two extremes, independent of model assumptions
- But analysis still ongoing to determine intermediate cases

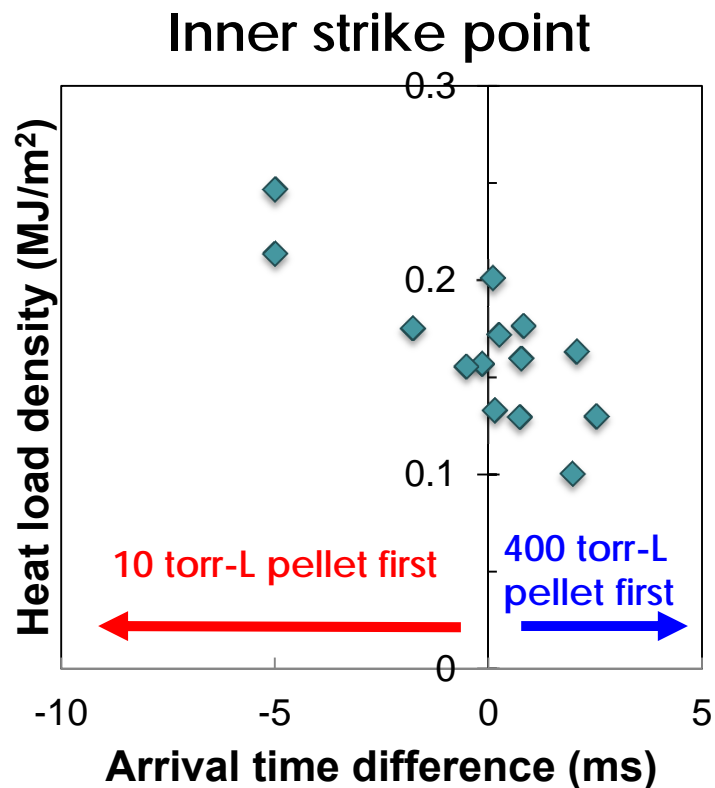

Different
fit/model

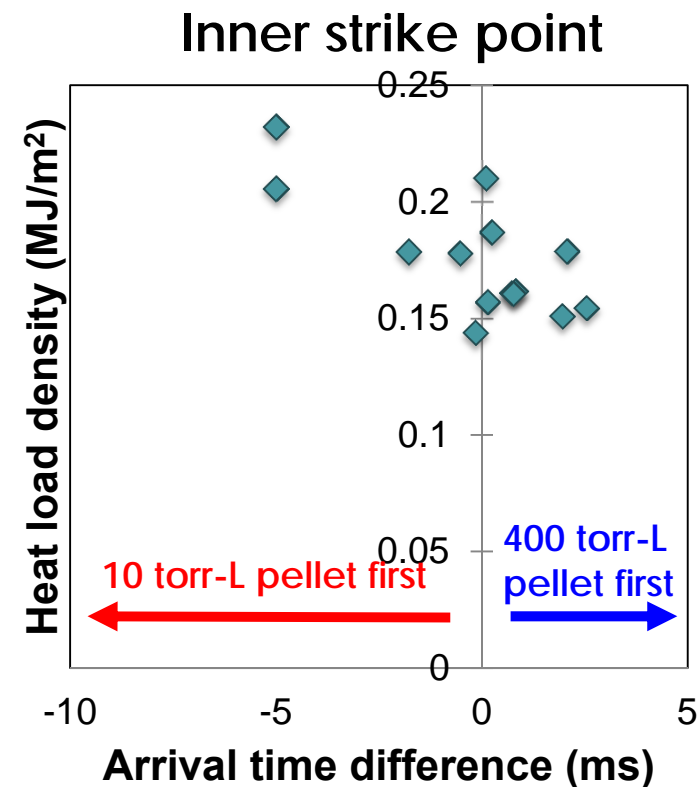

Two pellets cause plasma to disrupt sooner, may be key parameter

- Cooling duration = time from pellet arrival until I_p -spike
- Impurities entering after this will have missed the TQ

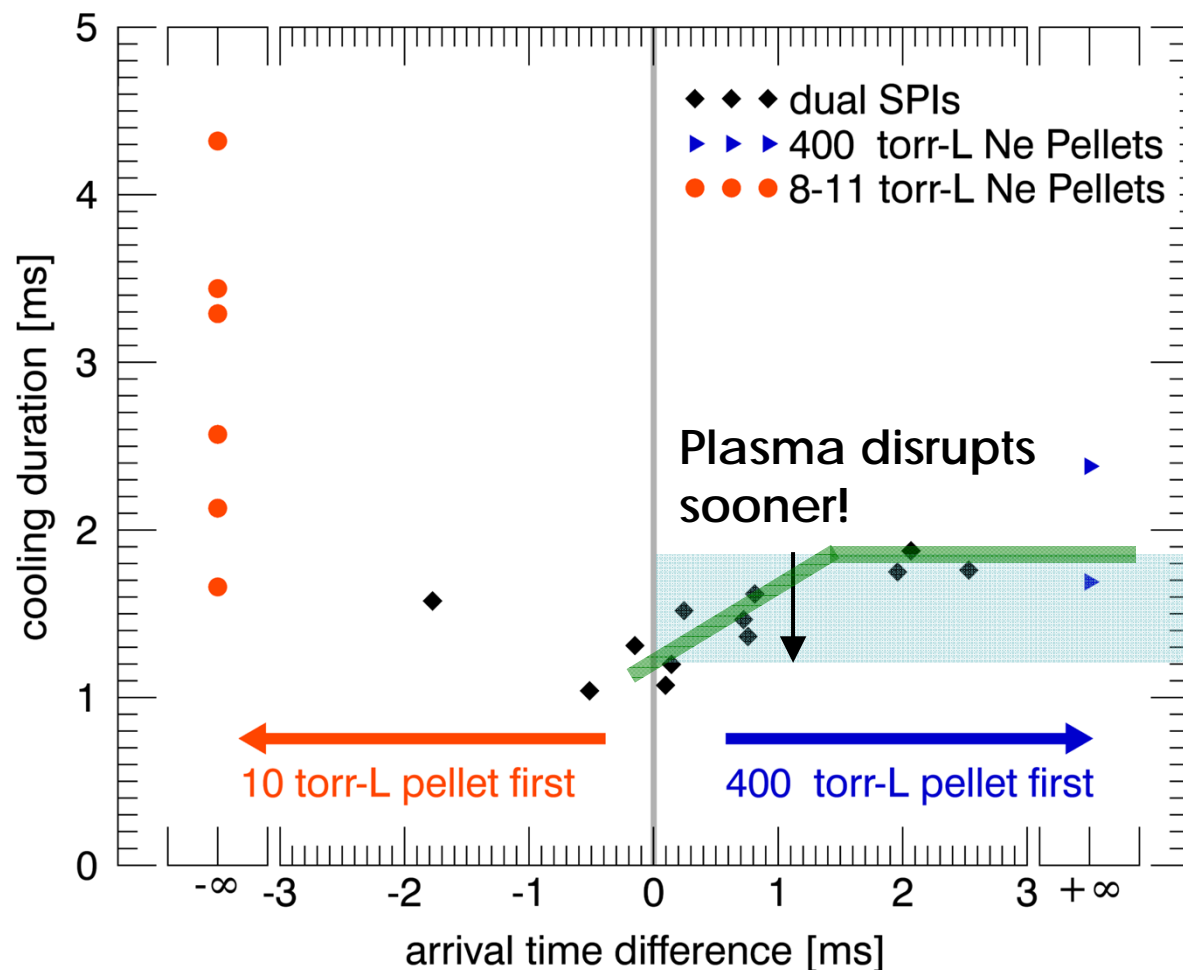
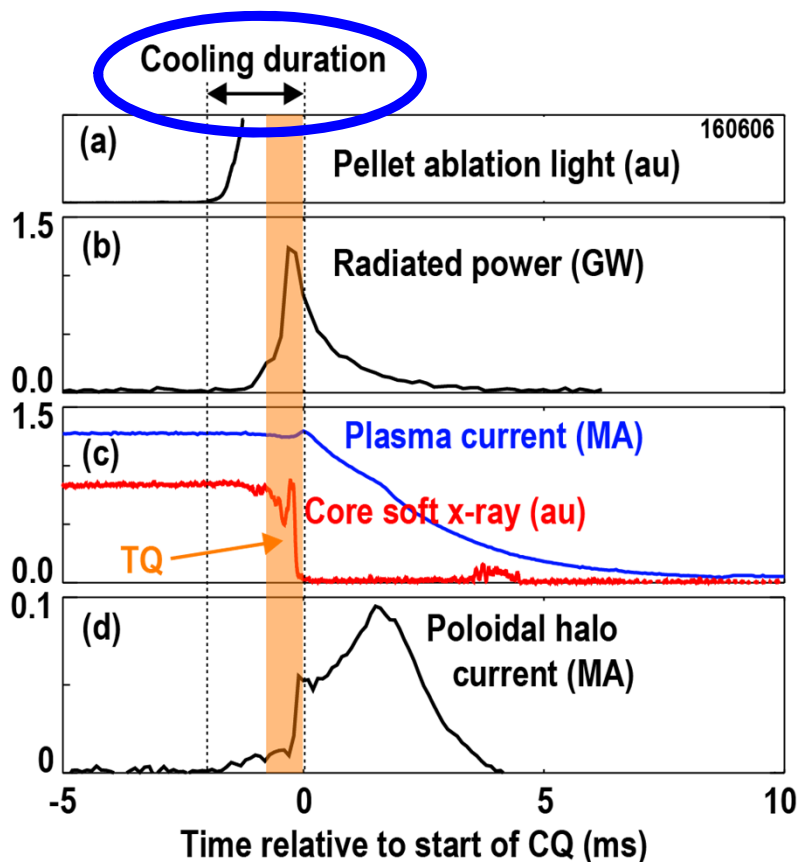

Possible mechanism by which two pellets reduce mitigation

Single pellet injected

- Impurities spread from injection port
- Eventually causes global thermal collapse (cooling duration)
- Lots of neon enters plasma before thermal collapse

→ Good mitigation

Two pellets injected from different ports simultaneously

- Impurities have a head start on spreading (toroidally/poloidally)
- Global thermal collapse occurs sooner
- Less neon enters plasma, compared to single-pellet case

→ Less effective mitigation

Measurement of radiation at different toroidal angles are not consistent

- No obvious trend measured at 210°
- Possible explanations
 - Radiation asymmetry
 - Diagnostic problem
- Even if there were asymmetries... what is the globally averaged performance?

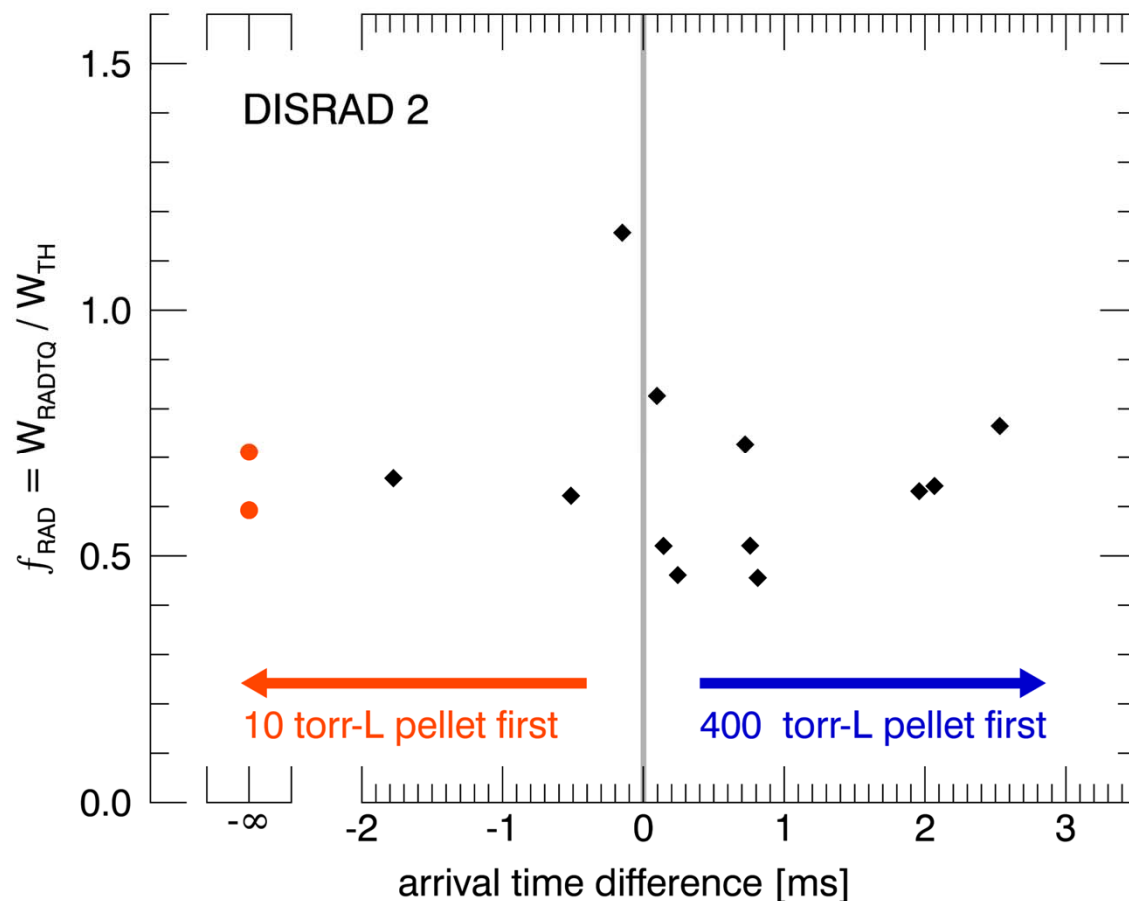

Outline

- Characterizing asymmetric effects
 - One pellet at a time, from different ports
- Mitigating thermal and EM loads with multiple pellets
 - Two pellets together, one from each port
- **Additional capabilities, and future work**

Effectiveness of ITER SPI may depend on transport mechanisms

- **SPI** far more effective than **MGI**
 - Ballistic transport of solid fragments to plasma core
 - More instantaneous delivery

Centrally peaked deposition

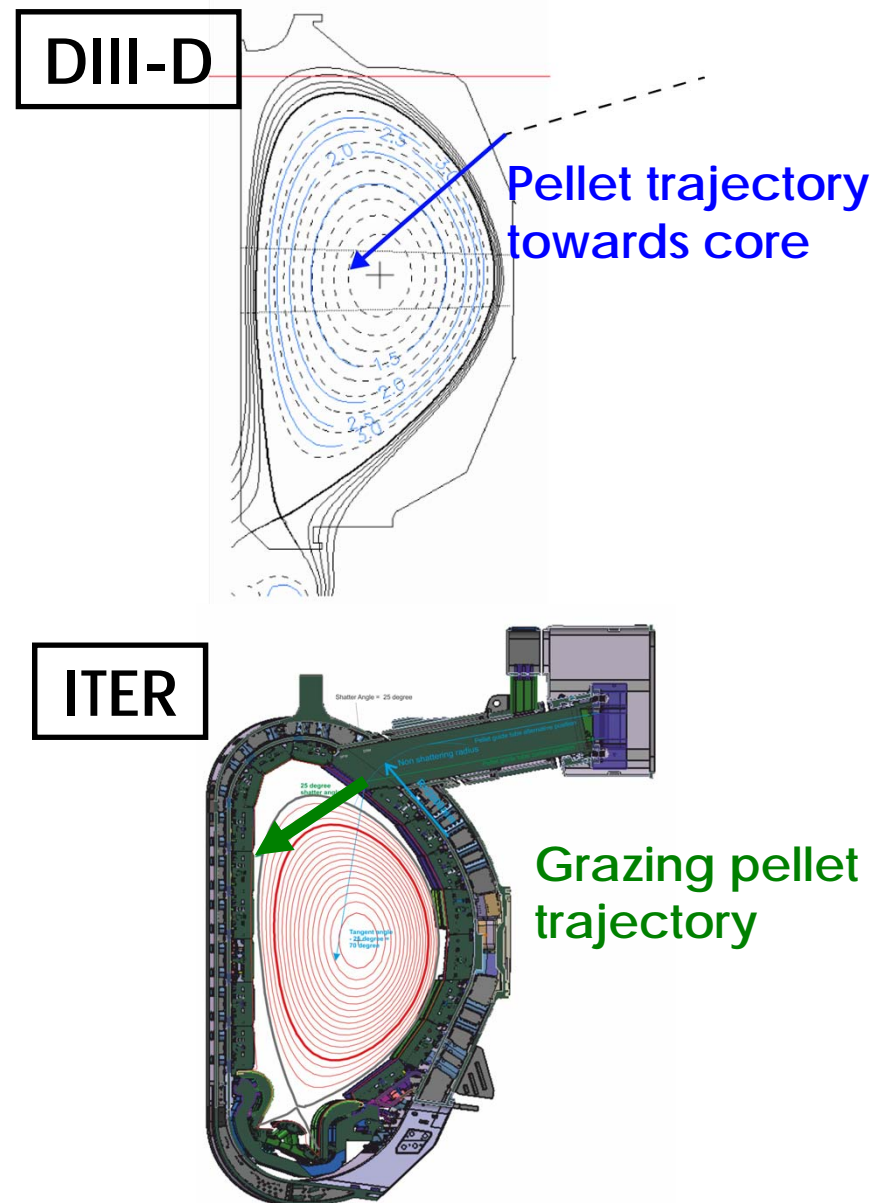
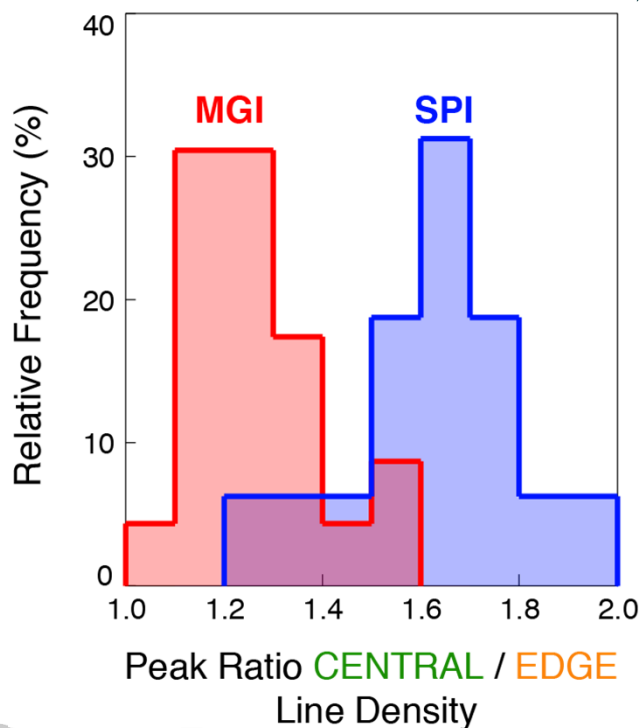

Rotated SPI limits initial deposition to plasma edge

- Shatter tube rotated along its axis, to change pellet trajectory

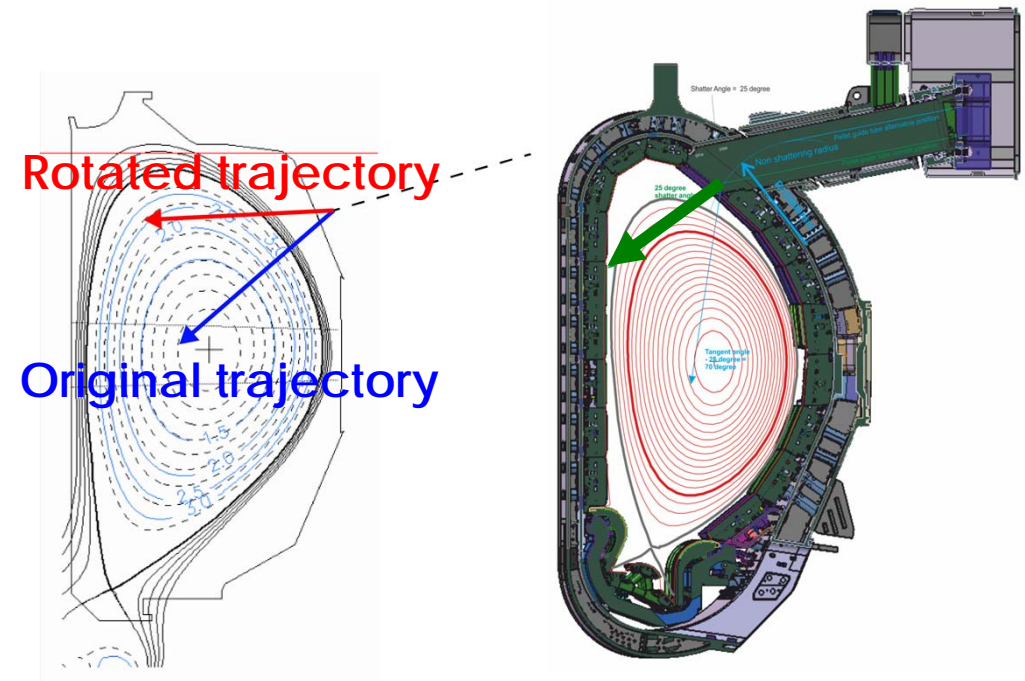
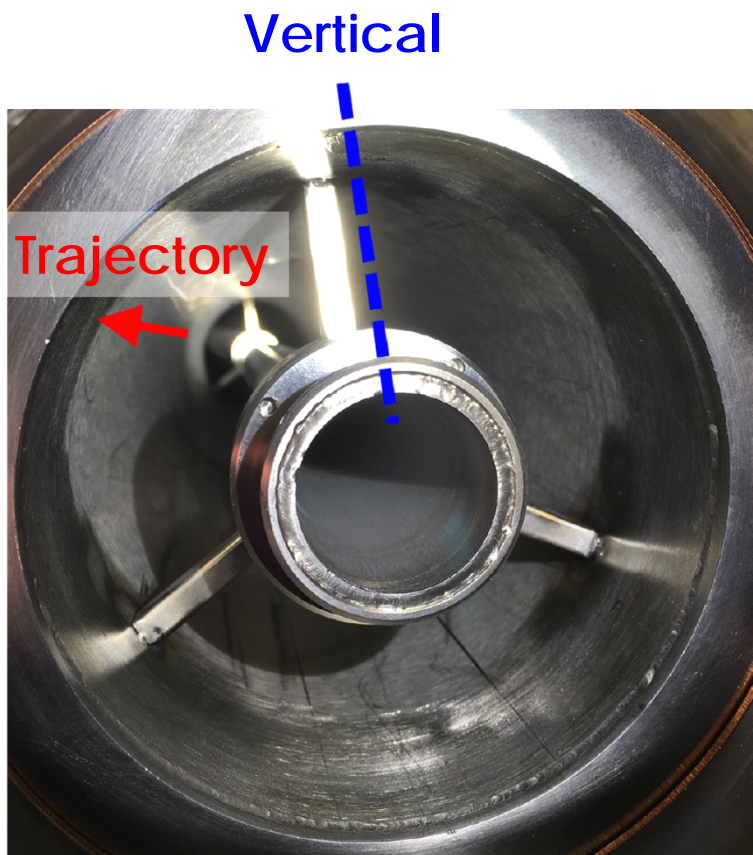

- Experiment scheduled for later this campaign

Mechanical punch will allow injection of argon shattered pellets

- Punch to be installed soon, to allow argon pellet injection
 - Higher Z
 - Higher solid fraction

- Allows pure neon pellets, without D₂ “grease”
 - May increase dissipative properties for secondary injection into existing runaway beam

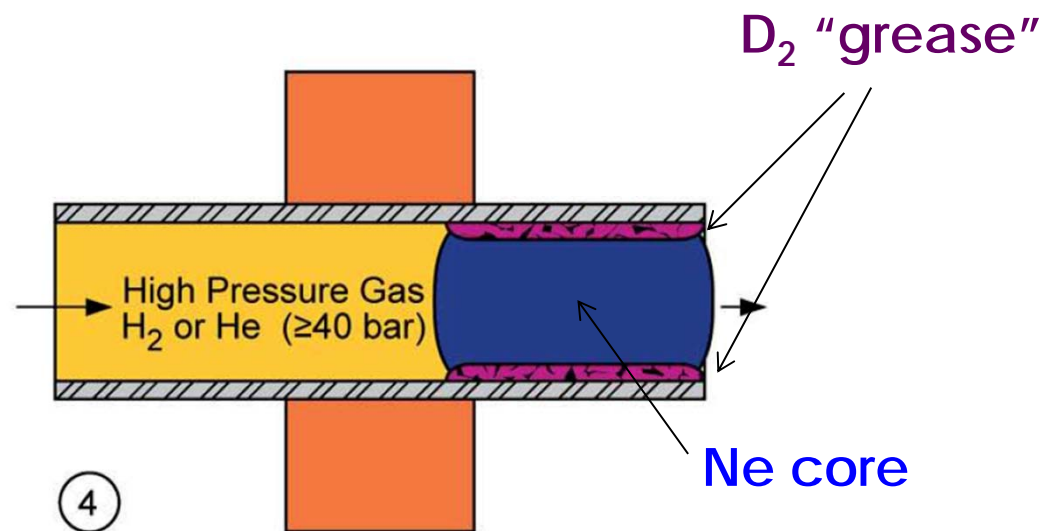
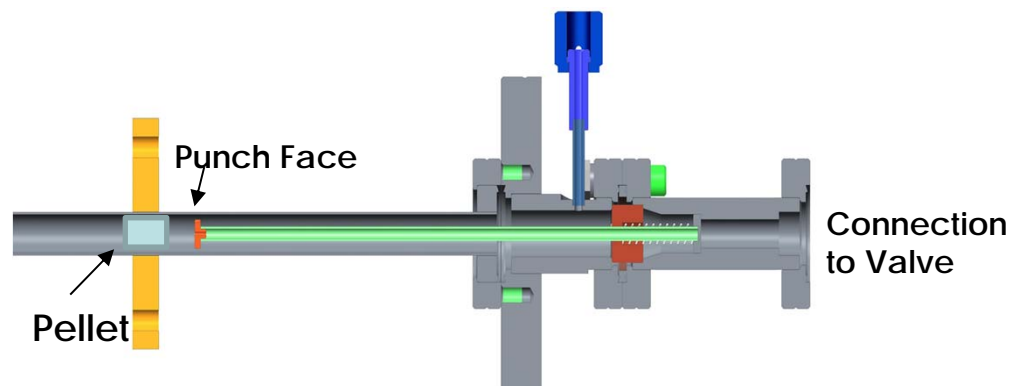

Summary: Addition of 2nd SPI system beginning to generate first results

- Slight difference in mitigation between the two injectors observed, but still good mitigation overall
- No obvious evidence of localized heat loads caused by radiation asymmetry (so far)
- Multiple pellets may actually reduce mitigation, compared with a single pellet
- Possible mechanism: multiple pellets causes disruption sooner, which may reduce amount of neon entering pre-TQ plasma

Measured variation of TQ properties with pellet composition

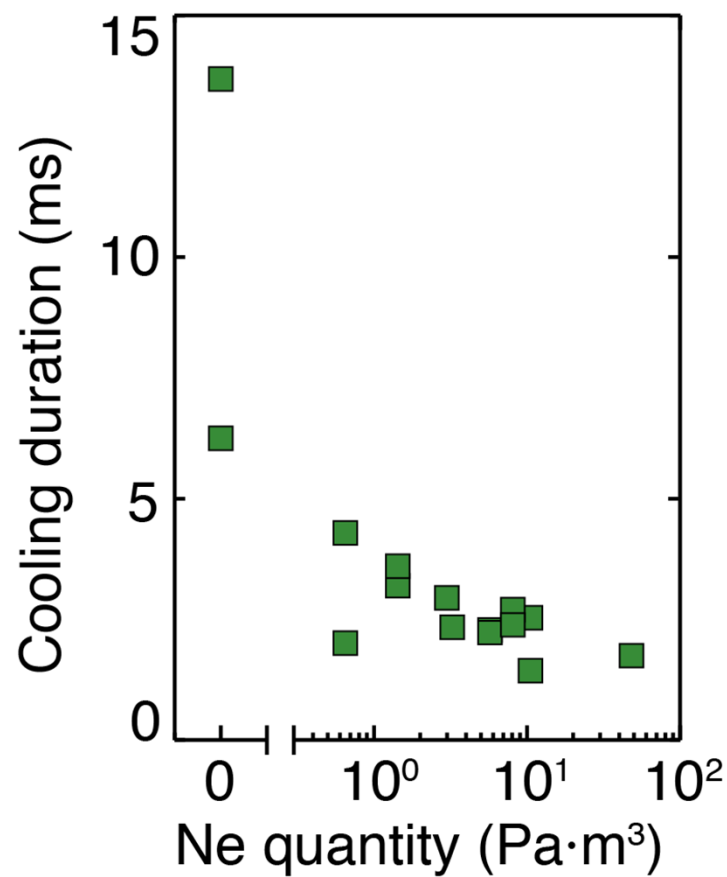
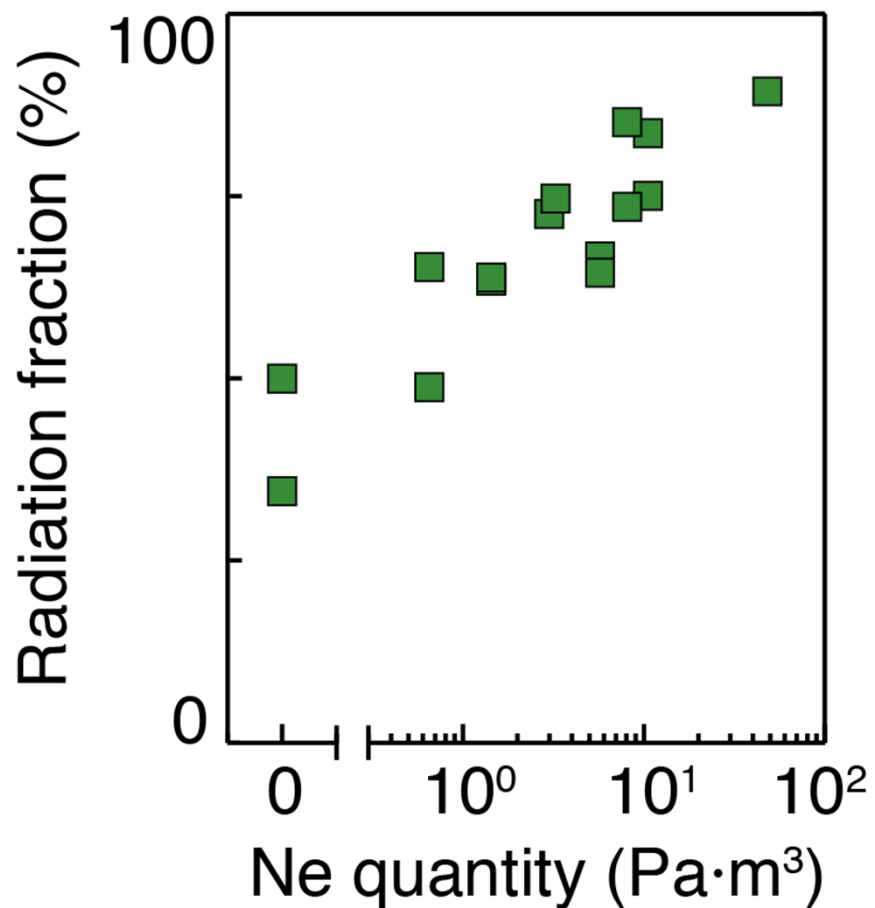

Measured variation of CQ properties with pellet composition

